

Canon

EOS 30D

WHITE PAPER



THE CANON EOS 30D:

**AN EXTRAORDINARY
FUSION OF
PERFORMANCE,
CONVENIENCE AND
VALUE**

Table of Contents	I. OVERVIEW	3
	II. NEW AND IMPROVED FEATURES	5
	III. CAMERA CONTROLS	6
	Picture Style	6
	Noise Reduction	7
	Files and Folders	7
	Ease of Operation	7
	Image Recording	8
	Image Playback	8
	Menus	9
	Exposure Control	10
	Custom Functions	10
	White Balance	11
	IV. SOFTWARE AND EXTENDED COMPATIBILITY	12
	Software	12
	Direct Printing	13
	Direct Image Transfer	16
	Accessories	16
	V. PERFORMANCE, DESIGN AND CONSTRUCTION	18
	LCD Monitor	18
	Design and Construction	18
	New Lenses	20
	Shutter Release Mechanism	21
	Drive Speed and Burst Performance	22
	Viewfinder	22
	Autofocus	23
	E-TTL II Autoflash	23
	Power Source, Shooting Capacity and Startup Time	23
	VI SPECIFICATIONS	25
	VII CONCLUSION	30

I. OVERVIEW

The new Canon EOS 30D digital SLR is a meaningful upgrade of the widely admired and immensely successful EOS 20D model. The EOS 20D was among the first mid-priced DSLRs to gain broad support, not just from advanced amateurs and serious photo hobbyists, but from a wide range of working professionals: wedding and portrait photographers, journalists, sports shooters, press organizations and newspapers. It was number one in its category virtually from start to finish over its 18-month market life, an outstanding accomplishment for any digital SLR in this highly competitive time.¹ Its biggest rivals turned out to be other EOS cameras, first the Digital Rebel XT, which was priced below it, and then the more expensive EOS 5D. Now, new adversaries have emerged and the time has come for Canon to move on.

The reasons for the EOS 20D's success are not hard to figure out. First, it produced exceptionally high quality images, particularly at ISO 400 and above. The EOS 20D delivered accurate color and excellent detail with speed and precision, even in adverse lighting conditions. Without this, obviously, nothing else would matter. Next, it was both compact and rugged. Its handling was fast and easy, with logical controls and many custom functions for tailoring the camera to particular situations and tastes. Finally, the price was right. At \$1,499, its introductory price was sensible for the many pros who have to pay for their own equipment and for the equipment pool managers who have to stay within budgetary limits. Many EOS 20Ds have been "ridden hard and put away wet," only to serve loyally the next day. The EOS 30D is a thoughtfully conceived and meticulous "rev up," an exciting new model that retains the best core features of the 20D while improving virtually all other camera functions.

Canon is a company with immense technological prowess. In 2005, it was second among all corporations in the number of patents granted to it by the U.S. Patent and Technology Office.² As great an achievement as this was, it was no surprise to those who know about such things. Canon has been in the top 3 for the past 14 years, consecutively, and Canon is number 2 overall for total number of patents received in the past 10 years. Aside from manufacturing the CMOS sensors in Canon DSLRs, as well as the equipment that manufactures those sensors and the tools which maintain and adjust that equipment, Canon truly controls every step of the way in the image creation process, from optics to sensors to image processors to software to printing devices. Canon is in the highly



unusual position of being able to listen to the comments and requests of EOS camera users and to respond with precision.

The EOS 30D retains the best of the highly acclaimed basic functions of the EOS 20D: an 8.2 MP CMOS sensor, the DiGIC II Image Processor, 5 fps fast continuous shooting, a multilayer LPF (low pass filter), high-precision 9-point AF, a durable magnesium alloy body, a multi-controller and vast system compatibility. Some changes are shared with other EOS models, such as the 2.5-inch LCD monitor with a wide viewing angle, Picture Style settings and automatic noise reduction, while other enhancements appear for the first time, including the Print/Share button, extended PictBridge functions, enhanced auto-rotate functionality and improvements in Canon-to-Canon device linkage. Additional new features

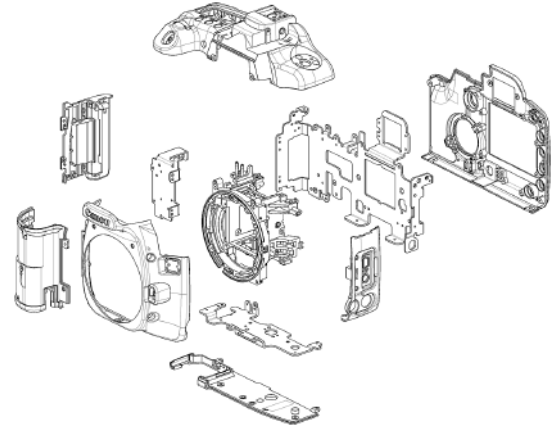

Exterior cover and internal construction

such as 3.5% spot metering, a tougher and more durable shutter, increased burst rate, more shots per battery charge, a low-speed drive mode, numerous improved shooting, recording and playback functions and faster startup all derive, at least in part, from user feedback.

After reviewing the feature improvements of the EOS 30D, it becomes apparent that Canon has managed to make this new camera far more suitable for professional applications, while at the same time maintaining its strong appeal to advanced amateurs. Whereas the EOS 20D could reasonably have been described as the “big brother” of the Digital Rebel XT, the EOS 30D is truly the “little brother” of its higher-priced sibling, the EOS 5D. This makes the 30D a compelling proposition for a wide range of customers, including:

- Digital Rebel or 20D owners who want to step up to the 30D’s improved features
- 5D or EOS-1 class owners looking for a professional quality backup camera
- Wedding and portrait photographers looking for exceptional image quality and professional features in a compact, lightweight package
- Photojournalists, other professionals and anyone else looking for outstanding performance at an affordable price

The EOS 30D has one more feature that is sure to make it even more appealing: an introductory price of \$1,399 for the body only, \$100 lower than the EOS 20D’s first price, and hundreds of dollars less than its competition. Remember, too, that Canon includes not only the battery pack and charger, strap, video and interface cables, but also a software package of great quality, completeness and usefulness. Canon does not expect its customers to purchase options just to make their cameras work.

¹ According to NPD Intellect Market Research.

² Source: <http://www.uspto.gov>

II. NEW AND IMPROVED FEATURES

- New 2.5-inch LCD monitor with approximately 230,000 pixels, wide viewing angle and substantially improved visibility
- Exceptional new direct printing capabilities, unique to Canon
- Picture Style controls make it easier to get what you want
- New, switchable high-speed/low-speed continuous shooting
- ISO settings in 1/3-stop increments with readout in viewfinder
- Reduced energy consumption for roughly 10% more shots per battery charge
- New 4-step battery level display
- New spot metering, same as EOS-1 Series and EOS 5D
- New, professional-quality shutter rated to approximately 100,000 cycles
- Great workflow improvement with upgraded software package, including (at no extra charge) ZoomBrowser/ImageBrowser, and Digital Photo Professional, backwards compatible to D2000 and D6000 of 1998
- Improved folder management with up to 9,999 images in each folder and file numbering with manual reset
- 0.15-second startup time, fastest of any EOS camera*
- 30-frame Large/Fine JPEG burst, up from 23 frames**
- 11 RAW frame burst, up from 6**
- Improved image playback functions, including new enlarge function in Quick Review as well as Playback, software-only auto rotate, and an improved jump function
- Enhanced Info screen with new, switchable RGB histogram as well as AF frame and File Size displays
- New auto noise reduction for long exposures with new Custom Function 02
- New magnified view with Custom Function 17
- Error code readout on back screen together with countermeasures help
- New display for image transfer failure using the WFT-E1A
- Improved recovery from Auto Power Off
- Single-shot AE/AF lock retained for subsequent shots
- Separate flash exposure (FE) lock icon displayed in the viewfinder
- Lower introductory price than EOS 20D

* as of February 2006

** compared to the EOS 20D



III. CAMERA CONTROLS

Picture Style

Picture Style, introduced on the Canon EOS-1D Mark II_N and the EOS 5D, is Canon’s new and genuinely improved approach to selecting presets that reflect most closely the photographic purpose and intent of the user. It consolidates Processing Parameters and Color Matrix and takes them a step further. Picture Style selection is like choosing a film type with the added benefits of being able to refine one’s film selection after “loading,” and the ability to change film properties significantly and repeatedly in mid-roll.



Style 1 – Standard is for users who do not intend to do any post-processing of their images. Right out of the camera, the pictures look crisp and vibrant, with the sharpness set to “3” and the color tone and saturation set to obtain vivid colors. Excellent prints will eventuate without any further adjustment. It is equivalent to parameter 1 on the EOS 20D.

Style 2 – Portrait has color tone and saturation settings that yield natural skin tones. The sharpness is set one step weaker than the Standard setting so that skin and hair look softer.

Style 3 – Landscape has color tone and saturation settings that give vivid blues and greens for skies and greenery. The sharpness is set one step stronger than the Standard setting so that the outlines of mountains, trees, and buildings look more crisp.

Style 4 – Neutral yields natural color reproduction, and no sharpness is applied. This setting is ideal for post-processing and is the same as the EOS-1D Series defaults.

Style 5 – Faithful is intended to match the original as closely as possible. It is the same as Faithful in Digital Photo Professional. When the subject is photographed in 5,200K light, the color is adjusted colorimetrically to match the subject’s color. No sharpness is applied. This setting, too, is designed for workflow that includes post-processing.

Style 6 – Monochrome with filter effects and color tones, is the same as the EOS 20D’s monochrome setting.

One can select a preset Picture Style (from Styles 1 through 5) and then, by pressing the Jump button, adjust sharpness (0 to 7), contrast (-4 to +4), color saturation (-4 to +4) or color tone (-4 to +4). Up to three additional user-defined Picture Style settings can be saved. Additional customized Picture Style files can also be downloaded via the Internet and set through the Camera Window software included in the package. When C.Fn-01-2 is set, pressing the SET button displays the Picture Style setting screen. The [Clear all camera settings] menu item causes all settings to revert to their defaults. In the EOS 30D, the Picture Style is automatically set for each of the Basic Zone modes:

Portrait and Landscape for their respective modes, and Standard for Full Auto, Close-Up, Sports, Night Portrait and Flash Off.

Noise Reduction

Selecting choice [1: Auto] in C.Fn-02, a new setting also available on the EOS 5D, enables auto noise reduction. For exposures of 1 second and longer, the EOS 30D then measures noise levels automatically and applies noise reduction only if it is determined that such a process would be beneficial. Causes of noise include the long exposure itself or high air temperature. Auto noise reduction is an excellent method for the management of dark frame subtraction because, most often, the camera is far better able to evaluate the presence of spurious data than the user. If noise reduction is performed, it takes the same amount of processing time as the exposure; the next shot cannot be taken until the process is completed. Unlike the EOS 5D, the EOS 30D cannot take any pictures while noise reduction is performed, a time equal to the length of the exposure.



When [2: On] is selected for C.Fn-02, noise reduction is always performed for images shot with an exposure time of 1 second or longer. This is effective for the noise that occasionally occurs in a low-temperature environment because such noise cannot be detected automatically. In the case of both the “Auto” and “On” settings, noise reduction is performed regardless of the ISO setting. If the same shutter speed is used for continuous shooting in the shutter speed-priority AE mode or in the manual exposure mode, noise reduction will be performed on all the shots based on the first shot’s noise data. This can be quite effective for Auto Exposure Bracketing sequences when all of the exposures are between 1 and 30 seconds.

Files and Folders

In response to user requests, the number of images that can be saved in one folder has been increased from 100 on the EOS 20D to 9,999 as in the Canon EOS-1 Series and EOS 5D. Also, a file numbering manual reset function like the one on the EOS 5D has been added. The [Manual reset] option is now in the [File numbering] menu. When a reset is performed, a new folder is created and the image number begins with 0001. The folder selection function provided on the EOS 5D is not included on the EOS 30D.

Ease of Operation

Attention paid by Canon engineers to some of the finer details of camera functionality has made the EOS 30D faster and easier to use. The multicontroller’s operation and diagonal scrolling have been improved with new firmware and a re-shaped controller. A Print/Share button has been added to the upper left of the back of the camera. The button is used for Direct Print, when printing images directly from the camera, and Direct image transfer, when the camera is connected to a compatible personal computer. In addition to turning power back on from Auto Power Off by pressing the shutter button

halfway (as on the EOS 20D), pressing the Playback button, the Menu button or the AE Lock button will now also perform the same task. This is another handy improvement.

Image Recording

The high-speed and high-quality image processing with the DiGiC II Image Processor, together with white balance adjustments, color space selection (sRGB, Adobe RGB), Design rule for Camera File System 2.0, Exif 2.21 and other basic specifications related to image processing and recording, protection and deletion, with the exception of Picture Style, are the same as those of the EOS 20D.

The thirteen possible combinations of image recording quality and their respective file sizes are given here:

Image-recording Quality		Pixels (Approx.)	Image Type	Compression Rate	Single Image Size (Approx. MB)	Possible Shots (Approx.)	Print Size
Large	Fine	3504 x 2336	JPEG	Low Compression	3.6	133	A3 or larger
	Normal	(8.20 megapixels)		High Compression	1.8	267	
Medium	Fine	2544 x 1696		Low Compression	2.2	225	A5 – A4
	Normal	(4.30 megapixels)		High Compression	1.1	442	
Small	Fine	1728 x 1152		Low Compression	1.2	392	A5 or Smaller
	Normal	(2.00 megapixels)		High Compression	0.6	761	
RAW+Large/Fine		RAW: 3504 X 2336 (8.20 megapixels)	RAW + JPEG	RAW Lossless Compression	—	39	—
RAW+Large/Normal						45	
RAW+Medium/Fine						44	
RAW+Medium/Normal						49	
RAW+Small/Fine						48	
RAW+Small/Normal						51	
RAW			RAW			8.7	

* The number of possible shots is based on Canon's testing standards and 512MB CF card.

* The single image size and number of possible shots will vary depending on the subject, shooting mode, ISO speed, Picture Style, etc.

Image Playback

As with the EOS 20D, the following is possible: Single image display (image plus basic information or image only/no information), shooting information display (information plus reduced image), 9-image index (9 images plus basic information or 9 images only), magnified view (magnified image plus basic information or magnified image only/no information), jump display (as on the EOS 5D), auto play, auto play right after shooting, image protect, and image rotation. When C.Fn-17-1 is set, the image can be magnified in the display right after shooting, making it easier and quicker to check focus. The content displayed for the single image with info mode is the same as on the EOS 5D. For the jump display, in addition to jumping by 10 images, one can now jump by 100 images or jump by shooting date. This feature is especially convenient when there are many images on the CF card.

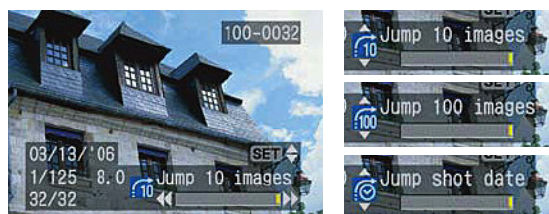

The shooting information on the EOS 30D now includes, usefully, the file size, histogram for brightness or RGB (brightness only on the EOS 20D) and the AF point used for the shot (when the [AF points] menu option is set to [Display]). In addition, there are: Folder number, File number, the reduced image, Color space, Shooting date/time, ISO speed, Metering mode, Shooting mode, Shutter speed, Aperture, Exposure compensation amount, Flash exposure compensation amount, White balance correction amount, Playback number/Total images recorded, Protect, Recording quality, Original image verification data appended, White balance, Color temperature (displayed only when WB setting is in Kelvin), Monochrome and File size (MB). The AF point is displayed only when Menu [AF point] > [Display] is set. When an image shot in RAW + JPEG mode is played back, the JPEG image size is displayed.

The camera setting display now has the Picture Style setting and WFT-E1A image transfer failure indicator, neither of which appears on the EOS 20D and the latter is new to EOS DSLRs. Conversely, absent on the EOS 30D's display are the AEB setting, processing parameters and image confirmation time, all of which were found on the EOS 20D's display. Additional information on the EOS 30D screen includes: Date/time, Color space, WB correction amount, WB-BKT setting, Auto power-off, Auto rotate, Flash exposure compensation amount, Color temperature value, CF card space remaining and ISO speed. In the Basic Zone modes, items that cannot be set will not be displayed. For example, ISO auto is shown rather than the actual number.

Menus As with the EOS 20D, one scrolls to select the desired item in the menus. The Jump button takes the user to the top item in each category (Shooting, Playback and Setup, color-coded red, blue and yellow, respectively). Any of 15 languages can be selected for the LCD monitor. The GUI's basic design is the same as the EOS 5D's.



The following menu functions are new: Transfer order, AF points [Not display/Display] and Histogram [Brightness/RGB]. If AF points are set to [Display], the AF focus points appear over the image on the upper left of the screen in the Single-image display mode with Shooting information. The histogram has been improved to have a choice between [Brightness] and [RGB] displays in the manner of the EOS-1D series cameras. Brightness/RGB appears on the upper right of the screen in the Single-image display mode with Shooting information.

Vertical images can also be set to rotate automatically so that they are displayed upright on the camera's LCD monitor and/or on a computer screen. The three options are: auto rotate for both camera and computer (with compatible applications), rotate for computer only (not rotated on the camera, a feature new to EOS DSLRs) and auto rotate off completely.

	On	On	Off
Camera's LCD monitor			
Personal computer			

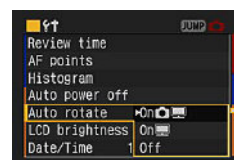

Picture Style and (when the WFT-E1A is in use) Images Failed to Transfer have been newly added to the camera setting information screen. With previous EOS cameras, an error code appeared on the LCD panel. On the EOS 30D, and new to EOS DSLRs, the error code appears on both the LCD panel and the LCD monitor along with appropriate countermeasures, making it much easier for the user to correct any problem which might occur.

This is a good example of the kinds of upgrades found on the new camera: thoughtful revisions, often suggested by users, which enhance the ease of operation and the overall performance of the EOS 30D.

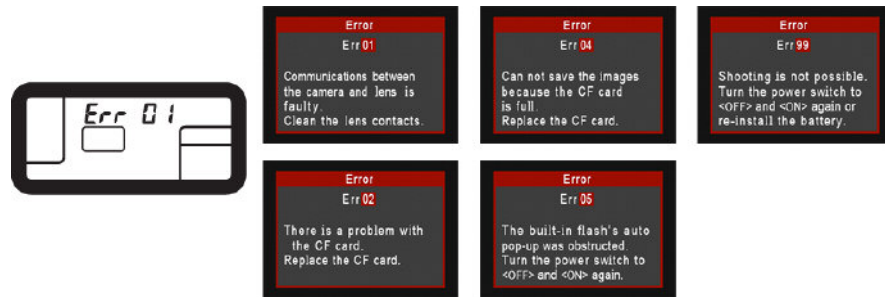

Exposure Control

The metering sensor is the same 35-zone unit in the EOS 20D. The basic metering optics are the same as the EOS 20D's, except that the metering sensor's angle of inclination behind the pentaprism has been optimized to provide spot metering.

With spot metering newly added, covering about 3.5% of viewfinder area at the center, the EOS 30D now has four metering modes. The other three modes are evaluative (set automatically in the Basic Zone modes), partial (approximately 9%), and center-weighted averaged. The algorithms for evaluative metering, E-TTL II and the exposure control modes (seven AE modes plus manual) are the same as the EOS 20D's.

The ISO speed can now be set from ISO 100 to ISO 1600 in 1/3-stop increments: 100, 125, 160, 200, 250, 320, 400, 500, 640, 800, 1000, 1250, and 1600. With C.Fn-08, [ISO expansion], ISO 3200 can also be set.

With the EOS 20D, the ISO speed could be displayed only on the LCD panel. On the EOS 30D, the ISO is also displayed in the viewfinder when the ISO speed button is depressed; setting can now be accomplished without removing one's eye from the finder.

In "ISO auto," the ISO speed range set automatically in the Basic Zone modes is the same as with the EOS 20D. In the Basic Zone modes, the ISO cannot be set manually, whereas in the Creative Zone modes, the ISO cannot be set automatically. During continuous shooting, the ISO speed does not change. In the Landscape mode, if the shutter speed is faster than 1.25 times the reciprocal of lens focal length, ISO 100 is set.

Custom Functions

The EOS 30D has one new custom function and an addition to an existing one, resulting in 19 custom functions with 53 possible settings. Entirely new is C.Fn-17, Magnified view. With option [0: Image playback only], magnified view is possible after one presses the Playback button to display the image. With option [1: Image review and playback], magnified view is possible after one presses the Playback button (as with the 0 setting) as well as during the image review immediately after shooting. During the image

review, hold down the Print/Share button and press the Magnify button to magnify the image. Once magnified, the AF point selector enlarges and the AE lock button reduces the image. When option 1 is selected but the image has not been magnified, these two buttons retain their regular functions.

C.Fn-02, Long exposure noise reduction, now has 3 options: Off, Auto and On. Please see “Noise Reduction” for a discussion of this feature.

Note that, when C.Fn-12-1 (mirror lockup) is set, the camera should not be pointed toward the sun or any bright light source. Doing so could damage the shutter curtains, cause stray light to enter or damage the imaging sensor.

White Balance

White balance controls are the same as on the EOS 20D. The modes are Auto (AWB, approx. 3000-7000K), six Preset settings (Daylight, approx. 5200K; Shade, approx. 7000K; Cloudy/twilight/sunset, approx. 6000K; Tungsten, approx. 3200K; White fluorescent, approx. 4000K; Flash, approx. 6000K), and two manual modes (Custom: photograph a white subject serving as the WB standard and use the [Custom WB] menu to specify that image as the standard; Color Temperature: specify directly from the [Color temp.] menu).

WB correction (Blue/amber or Magenta/green, +/- 9 levels, set with the multi-controller) can be applied to any of these settings within a range of 2000 to 10000K. WB bracketing can be enabled for three images at the current color temperature setting, then blue bias and then amber bias or current color temperature setting, then magenta bias and then green bias. The range is +/- 3 stops in one-stop increments. Because three images are recorded with one press of the shutter button, write times to the CF card increase proportionally. Also, when WB-BKT is set, the shots remaining will decrease to about one-third of the normal quantity. With C.Fn-09 [Bracketing sequence/ Auto cancel], the bracketing sequence can be changed and the bracketing can be canceled automatically.

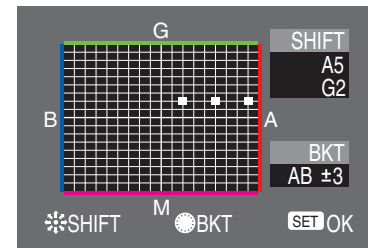

IV. SOFTWARE AND EXTENDED COMPATIBILITY

Software One of the many differences between Canon and the other manufacturers of DSLRs is the completeness, excellence and generosity of the software package Canon includes with each EOS Digital SLR. The EOS Digital Solution Disk Version 12 has the following components (in seven languages):

EOS Utility Ver.1.0 integrates and upgrades CameraWindow and EOS Capture, bringing together all the functions that involve communication with the camera. It is the gateway that allows users to download images to a computer, adjust camera settings, shoot photos remotely, monitor folders when the WFT-E1A wireless transmitter is used and even see images as they are shot. It supports automatic image transfer using the Print/Share button on the EOS 30D, as well as selectable linked display in Digital Photo Professional and ZoomBrowser/ImageBrowser. This means that Canon EOS users can now download their images directly into Digital Photo Professional, ZoomBrowser EX or ImageBrowser – a huge workflow improvement, integrated from shooting all the way to printing. EOS Utility Ver.1.0 is compatible with all EOS Digital SLRs from the EOS D30 onwards (Mac and Windows).

EOS Utility Ver. 1.0 Software configuration and linkages

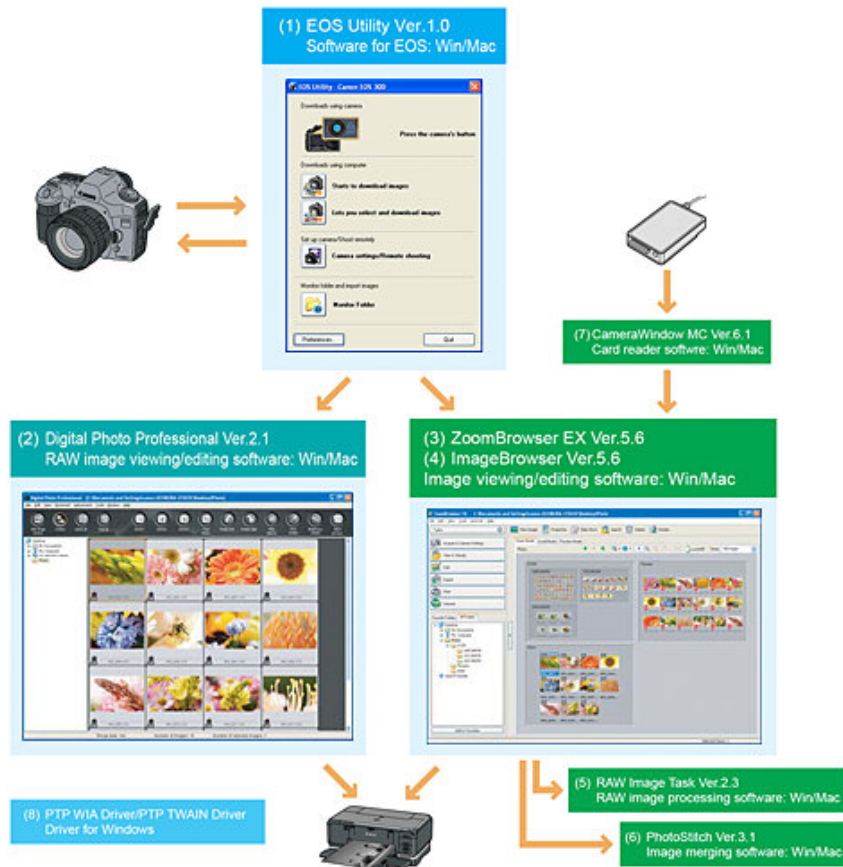

Digital Photo Professional (DPP) Ver.2.1 is a high-speed RAW image viewing/editing program, using Canon's own powerful algorithms, which yield the highest quality .CR2 RAW conversions of any application, regardless of cost, and it's free. Interestingly, the current 2.1 version not only adds support for the EOS 30D but also retroactively extends support back to the EOS D6000 and EOS D2000 from 1998 with the use of specialized data conversion software that transforms the .TIF files to .CR2. (Canon added EOS D30 compatibility with DPP 2.0.) As with the latest EOS Digital SLRs, Picture Style settings can then be applied to the RAW images and a range of current image editing functions can be used. Photographers and studios who have archived images in older recording formats will welcome the opportunity to make higher quality conversions than has ever been possible. Clearly, Canon is continuing to improve its support of RAW images for a growing range of EOS DSLRs.

Some upgrades from DPP 2.0 are significant. Noise reduction on RAW conversion has been added. The online instruction book is better and more hyperlinked. A Tone Curve Assist function has been added for the automatic adjustment of failed shots. Print specification functions have been enhanced. Images can be adjusted to any size; they can be positioned anywhere in the layout; the user can enter a header or a footer and the user can enter an image title or caption text. The shooting information can also be entered in the title or caption position and printed out with the image. Contact sheet printing now permits the user to specify from 1 to 40 images per row or column. Headers or footers can be entered and image file numbers or names can also be entered.

Easy-PhotoPrint Pro (previously only JPEG compatible and separate) can now be accessed through DPP and functions within DPP so prints can be made from RAW (or TIFF or JPEG) files without conversion. This Canon-to-Canon workflow saves time and disk space and requires no additional software to make excellent, faithful prints. Forthcoming 8-color printers from Canon will even have enough gamut to handle the Adobe RGB color space, wider than sRGB. Users of current EOS DSLRs will be able to use all the new DPP features.

ZoomBrowser EX Ver.5.6 (for Windows users) and ImageBrowser Ver.5.6 (for Mac users) are image viewing and editing applications that are ideal for users who shoot mostly JPEGs, as opposed to DPP which is for users who shoot mostly or entirely RAWs. Version 5.6 adds support for the EOS 30D. Workflow is integrated from downloading through printing. ZoomBrowser EX and ImageBrowser have several image display options, RAW image processing through RAW Image Task (version 2.3 included on EOS Digital Solution Disk Ver.12), support for sRGB and Adobe RGB, panoramic image merging through PhotoStitch (version 3.1 included on EOS Digital Solution Disk Ver.12), convenient image managing, JPEG editing and exporting functions. Processing algorithms are tailored to the camera, ensuring that images are processed with the same processing characteristics as those used on the camera. Third party software is unlikely to be able to do this.

CameraWindow MC (memory card) is image downloading software for use with card readers. It runs in linkage with ZB/IB, which do not support card readers directly.

PTP WIA Driver (Windows Me)/PTP TWAIN Driver (Windows 2000 and 98SE) is software for controlling communication between the camera and certain Windows computers. If the appropriate driver is not installed for these operating systems, the camera cannot

communicate with the computer. No separate driver is required for Windows XP or Mac OS X 10.2–10.4 because the OS driver is used.

Direct Printing

In addition to its standard PictBridge features, which are compatible with most PictBridge-compliant printers regardless of manufacturer, the EOS 30D supports additional direct printing features exclusively when the camera is connected to a new PIXMA Pro9500 or Pro9000 desktop photo printer, which are being announced simultaneously with the EOS 30D camera. These features include the following:

- Full support for Picture Style settings: Images are printed according to the photographer’s preferences for sharpening, contrast, saturation and color tone, as well as monochrome and other special effects.
- Fine adjustment of other image quality settings such as color balance, color space (including Adobe RGB), overall brightness, face brightness and microcontrast levels as well as a red-eye correction function.
- Expanded paper selection, including a range of fine art paper stocks available in a variety of sizes up to 13" x 19".

These additional direct printing features are being introduced to meet the needs of camera users who pay close attention to details and want to fine-tune their image quality to the highest possible degree. As a result, customers who purchase the EOS 30D camera together with a compatible PIXMA Pro Series printer will achieve levels of quality and convenience that are only available with this new Canon-to-Canon solution.

In previous direct printing, the colors shot by the camera were automatically corrected by the printer during printing. The user could neither print images using the camera’s unmodified color characteristics nor look at a print and make fine adjustments to color tones. With an EOS 30D/ PIXMA Pro Series printer combination, a full range of print effects is now possible. Images can now be printed using the camera’s color characteristics without automatic correction by the printer, a particular advantage when printing from a camera with Picture Style. When necessary, the conventional print mode with automatic correction on the printer is still selectable.



The following table shows the wide range of choices available for print optimization when using Direct Print. It lists selectable Print Effects across the top and manually adjustable print parameters in the left column.

Item	Off	On / Vivid	Natural	Natural M	B/W / Cool tone/ Warm tone
Brightness	-3 - 0 - +3	-3 - 0 - +3	-3 - 0 - +3	-3 - 0 - +3	-3 - 0 - +3
Adjust levels	Off	Auto	Auto	Off/ Auto/ Manual	Off/ Auto/ Manual
[Face] Brightener	Off / On	Off / On	Off / On	Off / On	Off / On
Red-eye correction	Off / On	Off / On	Off / On	Off / On	Off / On
Detail set.	Contrast	0	0	-3 - 0 - +3	-3 - 0 - +3
	Saturation	0	0	-3 - 0 - +3	0
	Color tone	0	0	-3 - 0 - +3	0
	Color Balance	0, 0	0, 0	0, 0	B/A, M/G: ±9

“Off” means there is no color level control; color tones are the same as “On.” With “On,” color levels are adjusted automatically using Exif information. Canon’s standard “Canon Digital Photo Color” is used for color tones. “Vivid” prints the blue tones of the sky and ocean and the green tones of plants more brightly. “Default” prints according to the settings of the connected printer. Without much automatic color adjustment by the printer, “Natural” prints the image with its actual colors as determined by the Picture Style setting. “Natural M” is the same as “Natural” except that one can apply all print adjustments, as shown in the table above. There are three new monochrome modes. “B/W” is neutral monochrome printing; “Cool tone” is cool, bluish monochrome printing, and “Warm tone” is warm, yellowish monochrome printing. Note that selectable printer effects may vary according to the printer in use.

In the left column, “Brightness” cleverly increases or decreases the brightness of midtones +/- 3 stops while retaining the darkest (shadow) and lightest (highlight) areas intact. With “Adjust levels,” the darkest and lightest areas are specified automatically or manually, and the image can be printed to match the brightness in between the lightest and darkest areas. The “Auto” option analyzes the image automatically to detect shadows and highlights. The optimum level correction is then performed. With the “Manual” option, shadows (0-127) and highlights (128-255) are specified manually and the level correction is performed.

In backlight, the subject’s face sometimes becomes dark. With the “Face Brightener” function, the difference between the brightness of the background and the brightness of the subject’s face is automatically detected and the face is then lightened when printed. This feature is supported by some inkjet printers but is unsupported on CP printers.

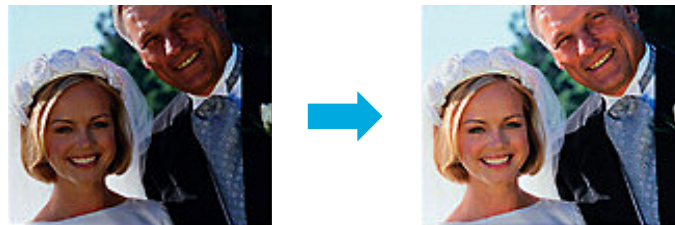

In flash photography, red-eye is a common occurrence. The “Red-eye correction” function automatically detects and corrects this condition when the image is printed.

The print layout function was not on the EOS 20D but does appear on the EOS 30D, as well as the EOS 5D and the EOS-1D Mark II N. The options are: Print with Exif shooting information, 20-image index plus shooting information, 35-image contact sheet index and 2/4/8/9/16/20/35-image layout. These options are supported by all PictBridge-compatible PIXMA and PIXMA Pro Series photo printers announced since the second half of 2005.



20-image Print with Shooting Information



Single-image Print with Shooting Information



35-image Contact Sheet

Direct Image Transfer

The EOS 30D is the first EOS camera to incorporate direct image transfer to a computer. New to the EOS line are camera-side controls similar to those used on PowerShot cameras. To perform this task, an EOS 30D, a Windows or Macintosh computer with the EOS Digital Solution Disk Ver.12 installed, and the USB Interface Cable IFC-400PCU are required. The transmission protocol is PTP, so select [Print/PC] from the [Communication] menu. With the [Transfer order] menu item, one can specify images (JPEG or RAW) to send to a computer. (If the images were shot in RAW+JPEG mode, both RAW and JPEG will be sent, except in the case of the wallpaper option, in which case only the JPEG will be sent.)

Images are transferred to the computer when the SET button or the Print/Share button is pressed. The options are:

- All Images- All the images on the CF card will be transferred.
- New Images- Images not yet transferred are automatically selected and transferred.
- DPOF Transfer Images- Images selected with the [Transfer order] menu item are transferred.
- Select & Transfer- The image is selected individually and transferred.
- Wallpaper- The image is transferred as wallpaper for the personal computer. The image is resized automatically to match the computer screen. The wallpaper will then appear on the computer screen immediately. Note that the image displayed as wallpaper might have a different horizontal/vertical aspect ratio from the original image.

The transferred images will be organized in folders by date. They will be stored in the [My Pictures] folder (Windows), or [Pictures] folder (Mac).

When the direct image transfer screen is displayed, the Print/Share button lights in blue during which it functions as a SET button. However, if All Images, New Images, or Select & Transfer has been set, pressing the Print/Share button will start the transfer immediately. One need not select [OK] on the confirmation screen.



Accessories

The EOS 30D uses the same accessories as the EOS 20D, as well as, of course, virtually the entire Canon EOS System. The BG-E2 Battery Grip produces 10% more available shots in combination with the EOS 30D than it does with the EOS 20D. The BG-E2 uses up to two BP-511/511A/512/514 battery packs. The optional Battery Magazine BGM-E2 allows the use of six AA-size alkaline or Ni-MH cells instead. The grip has vertical camera operation controls which make vertical shooting easy and comfortable.

The semi-hard case is the same item used with the EOS 20D, the EH-17L. It accommodates the following lenses when mounted on the EOS 30D: EF-S 17–85mm f/4.0–5.6 IS USM, EF 24–85mm f/3.5–4.5 USM and EF 28–105mm f/3.5–4.5 II USM. The Wide Strap EW-100DGR is also the same strap used on the EOS 20D.

The Wireless File Transmitter WFT-E1A is a useful accessory for fields in which real time image transfer is needed, such as studio



Wireless File Transmitter
WFT-E1A

and press photography, sports and entertainment. It allows image transfer via wired or wireless LANs compliant with IEEE 802.11 b/g and 100-BaseT Ethernet.

The Data Verification Kit DVK-E2 addresses a substantial issue in digital photography: it allows tampering with image data to be detected. The kit is for use in fields in which high levels of image authentication are required, such as press reporting, law enforcement and insurance work.



Data Verification Kit DVK-E2

The optional Battery Charger CA-PS400 allows the user to charge two BP-511/511A/512/514 battery packs at the same time. The CG-580 (plugs directly into an outlet, charges BP-500 series batteries) and CB-5L (corded) are single battery chargers. (CG-580 is supplied with the EOS 30D.)

Included with the camera are the Video Cable VC-100 and the USB Interface Cable IFC-400PCU.

There are some EOS System accessories that have restrictions on their functions when they are used with the EOS 20D and 30D. Any system accessories not listed here is completely compatible with the EOS 30D:

Accessories with Restrictions

Interchangeable Lenses	
Lens Mount Converter FD-EOS	Although it can be used with manual exposure, exposure error occurs. Therefore, these items will be officially listed as incompatible.
Macro Lens Mount Converter FD-EOS	
Speedlites	
480EG	Compatible with external flash metering and manual flash (TTL autoflash not possible).
540EZ	Compatible with manual flash (does not fire in A-TTL/TTL autoflash modes).
430EZ	
420EZ	
ML-3	Not compatible (since it only has autoflash modes, it cannot fire).
300EZ	
200E	
Wired multi-Speedlite accessories	Not compatible (since it cannot fire in Manual flash mode when used with TTL hot shoe adapter).
Remote Control	
Remote Switch 60T3	Compatible when used with RA-N3.
Wireless Remote Controller LC-3	Compatible when used with RA-N3. The 1SR cannot cancel the auto power off mode. Also, shutter release is not possible while the metering timer is not active. When it is ON, shutter release may not work when the shutter button is pressed completely in one stroke.
Wireless Remote Controller LC-4	The 1SR cannot cancel the auto power off mode. Also, shutter release is not possible while the metering timer is not active. When it is ON, shutter release may not work when the shutter button is pressed completely in one stroke.

V. PERFORMANCE, DESIGN AND CONSTRUCTION

LCD Monitor The most obvious external difference between the EOS 20D and the EOS 30D is the new 2.5-inch, 230,00-pixel TFT liquid-crystal monitor with its 170° wide viewing angle and six LED backlight modules. This is the same monitor used on the EOS-1D Mark II N and the EOS 5D, both released in the autumn of 2005. Compared with the unit on the EOS 20D, the new monitor has a viewing angle 1.94 times larger in all directions, is much easier to see in daylight, and has a font size about twice as large and 10% wider. The monitor has approximately 100% coverage for JPEG images and 5 levels of brightness adjustment with a gray chart displayed along with the image.

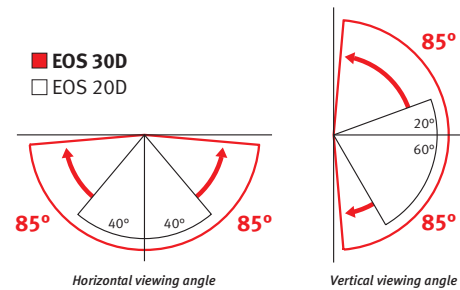

Design and Construction Some changes have been made to move the EOS 30D in the direction of the EOS 5D. The new, large monitor is unmistakable. (It accounts for a 20g increase in camera weight.) Shapes around the flash head and lens mount have been changed subtly to suggest Canon's upper-range models. The mode dial now has a metallic finish. The grip below the shutter button has been extended for better purchase with the middle fingers and improved overall handling. A new groove where the middle finger falls improves comfort and security. The body is 2mm thicker than the EOS 20D's, also enhancing comfort and security. Indented surrounds have been added to the row of four buttons on the back of the camera and the Delete key has been given its own location. Like the EOS 20D, the 30D is compact, solid, elegant, durable and purposeful. It is easy to carry and a delight to hold and use. The real design and construction story, though, is the extent to which numerous internal changes have made the EOS 30D a meaningful upgrade over the EOS 20D.

Like the EOS 20D, the EOS 30D's top, front and rear covers are made of a very light and strong magnesium alloy. Also, the left cover, where the USB port, video port and other external interface terminals are located, is made of special engineering plastic which also serves as an electromagnetic shield.

The main body is made of a stainless steel chassis and the mirror box is made of high-strength engineering plastic. Also, the lens mount and imaging element are fixed on the mirror box so that the flange focal distance does not change due to static pressure caused by the mounted lens. The mirror box is fixed solidly on the chassis to attain a body precision on a par with the EOS 20D.

The external paint is the same high-quality black satin leathery finish found on the EOS 5D. It suppresses fingernail scratches and the finer grain of the satin finish makes the

camera more comfortable to grasp.

The EOS 30D's basic internal construction and major parts configuration are the same as those of the EOS 20D. However, parts count data reveal the extent to which the EOS 30D has been reconsidered. The number of circuit boards, 28, is the same as in the EOS 20D, but lead wires have been reduced from 19 to 15. Optical parts count is the same, 20, but mechanical parts have risen from 301 to 338 and electrical parts have risen from 826 to 898. Screws and washers have declined slightly, from 167 to 164. In this tally, the shutter unit and DC/DC converter each count as one unit and the E-ring counts as a washer. It is clear from this and from the following discussion that the EOS 20D got a thorough going-through and that extensive changes have been made to enhance mechanical and electrical reliability, reduce sources of noise and improve overall performance.

The EOS 30D's basic circuit board configuration is based on the EOS 20D's. There are six rigid, printed boards centering on the digital control and camera control circuit boards, and 22 flexible printed boards on which the sensor and switches are mounted. It is different from the EOS 20D in that the 2.5-inch TFT monitor is incorporated; adaptation has been made for a different AE sensor package and soldering by hand has been eliminated.

The digital control circuit board is a highly integrated 10-layer board. It contains the following: the ADIC that converts the output from the CMOS sensor into digital signals, the imaging signal processing circuit that includes the IC that generates the CMOS sensor's drive pulse, the digital imaging processing circuit that includes the DiGiC II, the memory circuit that includes the DDR SDRAM for the image buffer memory, and other items such as the TFT liquid-crystal control circuit. The board's number 2 and 9 layers are GND layers to prevent signal interference between the external-layer pattern and the internal-layer pattern and to prevent undesirable phenomena caused by noise.

The camera control circuit board has six layers. It contains the following: the main microcomputer IC that regulates the camera's operation by controlling the various sensors and mechanical components, the display panel and viewfinder display drive control, the display microcomputer IC that controls various switches and the EEPROM that retains adjustment data (AE, AF, etc).

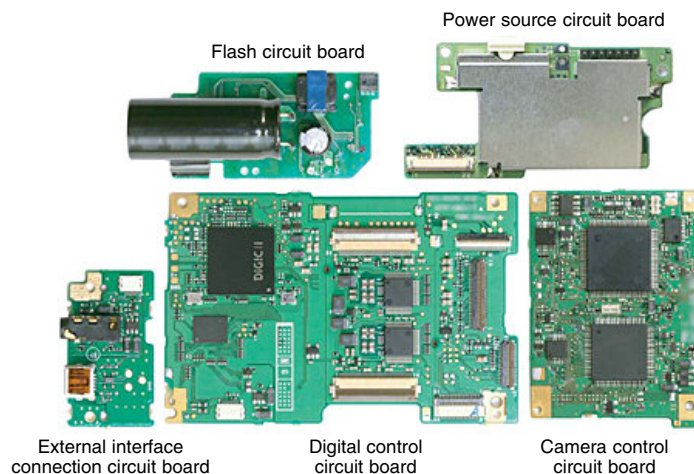

To make the camera smaller, the external interface connection circuit board has been separated from the digital control board and both sides are used. It has the USB port (MINI B), conforming to USB 2.0 Hi-Speed, and the video OUT terminal.

The double-sided flash circuit board is the same as the unit in the EOS 20D. It has the flash circuitry, electronic X circuit and the camera orientation circuit.

The power source circuit board has four layers. It has the power source circuits that generate the voltage necessary to operate the camera's circuits.

The sixth, rigid, printed board is on the improved shutter unit.

New Lenses

Two new and very different lenses that professional and advanced amateur photographers will find exceptionally appealing will become available at roughly the time that the EOS 30D reaches dealers. They are a large aperture standard zoom and an ultra-fast medium telephoto.



EF-S 17-55mm f/2.8 IS USM

The EF-S 17–55mm f/2.8 IS USM offers superb image quality, on a par with L Series lenses. It has a large maximum aperture which, combined with higher shutter speeds, can minimize subject motion blur. Shallow depth-of-field for separation of a subject from its background is much easier to achieve. The f/2.8 maximum aperture allows a bright finder and extremely precise focusing with f/2.8-compatible AF sensors. The internal stabilization has a sharpness benefit equivalent to a three stop faster shutter speed. Combining f/2.8 with IS makes the new lens outstanding in low light. As an EF-S lens, the new zoom is smaller, lighter and handier than a lens of similar specifications could be, but covers the full 24 x 36mm frame. This new lens would certainly be the “best match” for the EOS 30D except that it causes some vignetting when the built-in flash is used. The EF-S 17–55mm f/2.8 IS USM is expected to retail for \$1,149 and is sure to be adopted by photographers of every sort.



EF 85mm f/1.2L II USM

The EF 85mm f/1.2L II USM is a revision of the EF 85mm f/1.2L USM lens introduced in 1989. Its enormous maximum aperture and handy focal length made it a favorite of wedding, portrait and sports photographers. While its image quality has remained a benchmark, general improvements in AF speed over its years of service make it an excellent candidate for an AF update. A ring USM drive, a high-speed CPU and optimized AF algorithms achieve a great increase in AF speed over the older lens (roughly 1.8x, depending upon camera and conditions). Lens coatings have been optimized as well, minimizing ghosting and flare. Distance information is now provided for flash exposure calculations. The new lens now has a round aperture that helps to produce a beautiful background blur. The new 85mm has the same optical system as its predecessor, 8 elements in 7 groups.

The ground aspherical element, in the third position from the front, minimizes aberrations and provides superb image quality with high resolution and high contrast, even at maximum aperture, true to its L Series heritage. The lens uses a floating construction in which the final group (lens element 8) is fixed and the other lens groups

extend during focusing, suppressing aberration variations at medium and short distances and achieving excellent imaging performance over the entire imaging area.

In sum, wedding, portrait and sports shooters (primarily), as well as fashion photographers and anyone else with an interest in excellent and unique optics, will find the EF 85mm f/1.2L II USM an alluring and sophisticated tool. It is expected to retail for \$2,099.

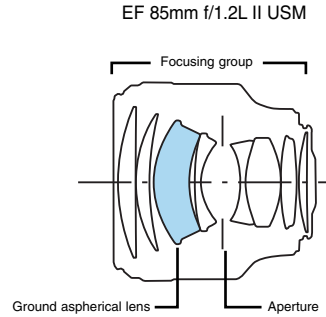

MTF Graph for EF 85mm f/1.2L II USM

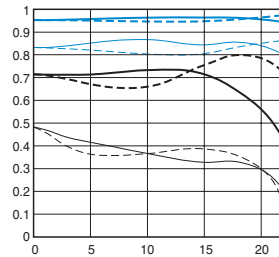

Spatial frequency	Maximum aperture	f/8
10 lines/mm	10 lines/mm	10 lines/mm
30 lines/mm	30 lines/mm	30 lines/mm

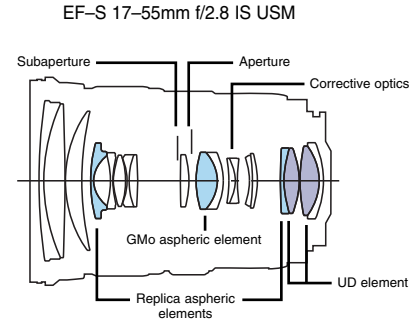

MTF Graph for EF-S 17-55mm f/2.8 IS USM

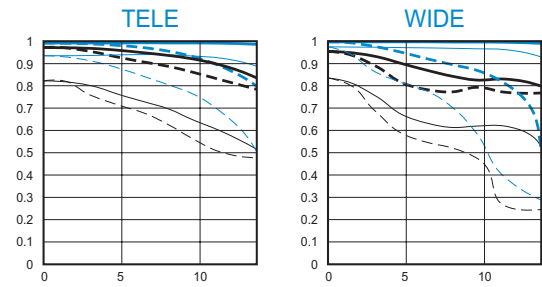

Spatial frequency (10 lines/mm)
 — Radial condition — Concentric condition
 Spatial frequency (30 lines/mm)
 — Radial condition — Concentric condition

• The closer the blue (10 lines/mm) line is to 1, the higher the contrast.
 • The closer the black (10 lines/mm) line is to 1, the higher the resolution.

AF speed comparison

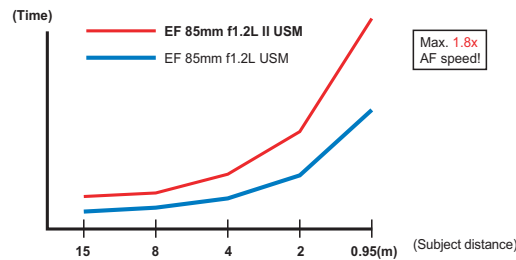

Circular Aperture Comparison

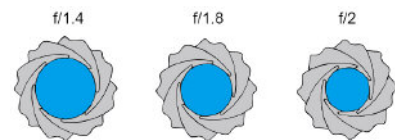

Shutter Release Mechanism

Although the shutter release mechanism is the same as the EOS 20D's, the EOS 30D's shutter button now allows the user to press it completely to take a picture, return it to the halfway position and then press it again to take another picture. This change responds to requests by EOS 10D and 20D users and works the same way as with EOS-1 Series cameras and the EOS 5D. The shutter release time lag from SW-1 ON is approximately 65 ms. (stop down within 3.5 stops of the maximum aperture) and the viewfinder blackout time is approximately 110 ms. Both are equal to or shorter than times on the EOS 20D.

Drive Speed and Burst Performance

The EOS 30D has a new drive mode called “Low-Speed continuous.” Its maximum speed is 3 fps. This feature has been added in response to users’ interest in specifying the number of continuous shooting frames and their request for longer continuous shooting even if fewer frames per second is the consequence. Users now have a choice of four drive modes; the other three are single, high-speed continuous and self-timer. An H mark has been added beside the continuous shooting mark on the LCD panel. In the Creative Zone mode, all four drive options are settable. In the Basic Zone modes, single, high- and low- are set automatically depending on the shooting mode and self-timer is settable.

A maximum continuous shooting speed of 5 fps can be attained in both the One-Shot AF and AI SERVO AF modes thanks to the CMOS sensor with 4-channel signal reading and the DiGiC II Image Processor.

With the EOS 20D and a DC motor (non-USM) lens, the maximum continuous shooting speed was 3.5 fps in the AI SERVO AF mode. An improved lens-drive algorithm has made it possible for the EOS 30D to achieve 5 fps under the same conditions.

An improved image processing sequence, in particular enhanced memory management during image processing, has increased the burst capacity of the EOS 30D to 30 frames during high-speed continuous shooting in the JPEG Large/Fine mode, even though the buffer memory capacity is the same as that of the EOS 20D. Also, in the RAW and RAW+JPEG modes, a different image processing method is used so that the maximum burst during high-speed continuous shooting is increased to approximately 11 shots in RAW and approximately 9 shots in RAW+JPEG Large/Fine. (The actual maximum burst depends upon shooting and processing conditions and the type of CF card in use.) In the EOS 20D, the maximum burst in both RAW and RAW+JPEG is 6 shots. The maximum burst is displayed at the bottom right in the viewfinder. “9” is displayed if the maximum is 9 shots or higher; a number from “8” to “0” is displayed if the maximum is fewer than 9. The maximum burst is displayed even when the drive mode is Single or Self-timer or if no CF card is installed. In the B/W mode, the maximum burst will be higher than when shooting is in color.

Image-recording Quality	Maximum Burst	
	High-Speed continuous shooting	Low-speed continuous shooting
L	30	37
L	55	100
M	50	60
M	100	165
S	105	240
S	220	850*
RAW L	11	11
RAW L	9	9

* Continuous shooting is possible until the CF card becomes full.

Viewfinder

The viewfinder’s basic optical construction, superimposed AF point display, Precision Matte focusing screen and specifications (95% coverage vertically and horizontally, 0.9x magnification with 50mm lens at infinity with –1 diopter, 20mm eyepoint, -3.0 to +1.0 diopter adjustment range) are the same as the EOS 20D’s. The FE lock icon, also on the EOS 5D, is an addition to the information display, allowing FE and AE lock to be indicated separately. Because the EOS 30D has a new

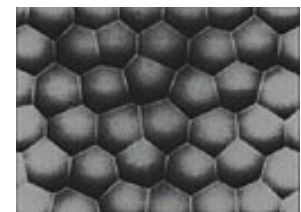

Microscopic view of Precision Matte focusing screen

spot metering feature, the metering zone mark in the center of the viewfinder has been changed to a spot metering circle which is smaller than the partial metering circle in the EOS 20D.

The quick-return mirror affords a viewfinder blackout time of only 110 ms at shutter speeds of 1/60 second and faster. Mirror lockup of up to 30 seconds is set with C.Fn-12-1. There is no mirror cut-off with lenses up to EF 600mm f/4L USM, a professional specification. A depth-of-field preview button is provided, enabled in the Creative Zone modes. With Canon Speedlites 580EX, 550EX, 430EX, 420EX, MR-14EX or MT-24EX, pressing the depth-of-field preview button fires a modeling flash.

Autofocus The AF sensor/modes/speed, selection ease, AF-assist beam and other AF-related specifications are the same as the EOS 20D's. With regard to AF precision, further fine-tuning has been incorporated compared with the EOS 20D.

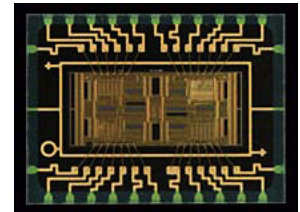

Metering sensor

E-TTL II Autoflash The specifications of the built-in flash are the same as those of the unit in the EOS 20D: E-TTL II autoflash, Guide number 13/43 at ISO 100 in meters/feet, coverage compatible with an EF-S 17mm wide angle lens (equivalent to an EF 28mm lens in full-frame 35mm format), 91.93mm between the optical axis and the flash head center and maximum flash sync speed 1/250 sec. To match the EOS 30D's improved shutter durability, a highly durable Xenon tube is incorporated to increase the service life of the built-in flash.

Flash exposure compensation can be set in 1/3- or 1/2-stop increments up to +/-2 stops. FEC for both the built-in flash and a Speedlite can be set with the camera. Autoflash is not possible with EOS-dedicated Speedlites other than the EX-series. The manual flash mode should be used instead, if it is available. ONE-SHOT AF is recommended for flash photography because the AF-assist beam cannot match predictive AI SERVO AF. When in the Landscape or Sports mode, use of an EOS-dedicated external Speedlite is not recommended because the flash would fire at all times whether or not it was desired. The C.Fn-09 setting applies only to AEB and WB-BKT, so, regardless of C.Fn-09 choice, the FEB sequence will follow the Speedlite's setting. Finally, when using the built-in flash, lens hoods should be detached to prevent flash coverage cut-off.

Power Source, Shooting Capacity and Startup Time

To compensate for the extra power consumed by the new 2.5-inch monitor, microcomputer power management has been incorporated. As a result, the number of possible shots exceeds that of the EOS 20D.









Battery Life

Temperature	Shooting Conditions	
	No Flash	50% Flash Use
At 20°C/68°F	Approx. 1100 shots	Approx. 750 shots
At 0°C/32°F	Approx. 900 shots	Approx. 600 shots

* The figures above are based on a fully-charged BP-511A and CIPA (Camera & Imaging Products Association) testing criteria.

With the addition of an “Imminent power exhaustion” step, the battery charge level display now has 4 increments, like the EOS-1 Series cameras

Battery Level Indicator

	Fully charged	Low charge	Almost completely discharged	Completely discharged
K234				
20D				

and the EOS 5D, so remaining charge can be indicated more precisely.

The EOS 30D can be powered by BP-511A/514/511/512 battery packs. The Battery Grip BG-E2 can accommodate two of these battery packs or six AA-size batteries, doubling shooting capacity. AC power is possible with the optional AC Adapter Kit ACK-E2.

Thanks to DiGIC II, an improved system processing sequence during startup and shorter startup processes, the EOS 30D boasts the fastest startup time of any EOS digital camera, 0.15 second (approximately). The EOS 20D is itself speedy, at 0.20 second.

VI. SPECIFICATIONS

TYPE **Type:** Digital AF/AE SLR
Recording Media: CompactFlash (CF) Card Types I & II
Sensor Size: 0.89 x 0.59 in./22.5 x 15.0mm (APS-C size sensor)
Compatible Lenses: Canon EF lenses, including EF-S lenses. (Focal length conversion factor: Equivalent to approx. 1.6x indicated focal length compared to 35mm format)
Lens Mount: Canon EF mount

IMAGING ELEMENT **Type:** High-sensitivity, high-resolution, single-plate CMOS sensor
Effective Pixels: Approx. 8.2 megapixels
Total Pixels: 8.5 megapixels
Aspect Ratio: 2:3 (Vertical:Horizontal)
Color Filter System: RGB primary color filters
IR Cut Low-pass Filter: Fixed position in front of the CMOS sensor

RECORDING SYSTEM **File Format:** Design rule for Camera File System2.0, Exif 2.21 compliant
Recording Formats: JPEG, RAW and RAW+JPEG simultaneous recording provided; RAW and JPEG images are saved as separate files in the CF card
File Size* (on CF Card): (1) Large/Fine: Approx. 3.6MB (3504 x 2336), (2) Large/Normal: Approx. 1.8MB (3504 x 2336), (3) Medium/ Fine: Approx. 2.2MB (2544 x 1696), (4) Medium/Normal: Approx. 1.1MB (2544 x 1696), (5) Small/Fine: Approx. 1.2MB (1728 x 1152), (6) Small/ Normal: Approx. 0.6MB (1728 x 1152); (7) RAW: Approx. 8.7MB (3504 x 2336) (Exact file sizes depend on the subject and ISO speed)
Folder Settings: Automatic folder creation/selection
File Numbering: (1) Continuous numbering, (2) Auto reset, (3) Manual reset (new folder created by user)
Color Space: Selectable between sRGB and Adobe RGB
Picture Style: Six preset Picture Style settings plus three user-defined custom Picture Style settings with individual adjustments for Sharpness, Contrast, Color saturation, 2nd Color tone, Filter effect, Toning effect for black and white images.
Interface: USB 2.0 Hi-Speed, NTSC/PAL for video output

WHITE BALANCE **Settings:** Auto, Preset (Daylight, Shade, Cloudy, Tungsten Light, White Fluorescent Light, Flash), Color Temperature (2,800–10,000K), Custom (read off white or neutral gray object)
Auto White Balance: Auto white balance with the image sensor
Color Temperature Compensation: White balance bracketing: +/- 3 levels in 1-level

increments White balance correction: blue/amber bias +/- 9 levels, magenta/green bias +/- 9 levels When blue/amber bias and magenta/green bias set together with White balance correction, white balance bracketing cannot be set to more than +/- 9 levels

VIEWFINDER **Type:** Eye-level SLR (with fixed pentaprism)
Coverage: Approx. 95% vertically and horizontally (Coverage against JPEG Large)
Magnification: 0.9x (-1 diopter with 50mm lens at infinity)
Eyepoint: Approx. 20mm
Built-in Dioptic Adjustment: : -3.0 to +1.0 diopter
Focusing Screen: Fixed, Precision Matte screen
Mirror: Quick-return half mirror (Transmission: reflection ratio of 40:60. No mirror cut-off with lenses up to EF 600mm f/4L USM)
Viewfinder Information: AF (AF points, focus confirmation light), Exposure (shutter speed, aperture, spot metering circle, exposure level, AE lock, exposure compensation, AEB level, ISO speed), Flash (flash ready, built-in flash recycling, red-eye reduction lamp on, high-speed sync, FE lock, flash exposure compensation, insufficient flash warning during FE lock), White balance correction, Maximum burst, busy, CF card full warning, CF card error warning, No CF card warning
Depth-of-Field Preview: Enabled with Depth-of-Field Preview button
Eyepiece Shutter: None

AUTOFOCUS **Type:** TTL-CT-SIR AF-dedicated CMOS sensor
AF Points: 9
AF Working Range: EV -0.5–18 (ISO 100 at 68°F/20°C)
Focusing Modes: One-Shot AF, Predictive AI Servo AF, AI Focus AF (Automatically selects One-Shot AF or AI Servo AF), Manual Focusing (MF)
AF Point Selection: Automatic selection, manual selection
Selected AF Point Display: Superimposed on viewfinder and LCD panel
AF-assist Beam: Intermittent firing of built-in flash

EXPOSURE CONTROL **Metering Modes:** Max. aperture TTL metering with 35-zone SPC
(1) Evaluative metering (linked to all AF points),
(2) Partial metering (approx. 9% of viewfinder), (3) Spot metering (approx. 3.5% of viewfinder), (4) Center-weighted average metering
Metering Range: EV 1–20 (ISO 100 at 68°F/20°C with EF 50mm f/1.4 USM lens)
Exposure Control Systems: Program AE (shiftable), Shutter-priority AE, Aperture-priority AE, Depth-of-field AE (non-shiftable), Full auto (non-shiftable), Programmed image control modes, Manual exposure, E-TTL II autoflash Program AE
ISO Speed Range: Equivalent to ISO 100-1600 (in 1/3-stop increments, ISO speed can be expanded to ISO 100–3200)
Exposure Compensation: Up to +/-2 stops in 1/3- or 1/2-stop increments (1) User-set

with multi-controller (2) AEB (Auto Exposure Bracketing)

AE Lock: Auto: Applied in One-Shot AF mode with evaluative metering when focus is achieved / User-set: Applied with AE lock button

SHUTTER **Type:** Vertical-travel focal-plane shutter with all speeds electronically-controlled
Shutter Speeds: 1/8000 to 30 sec. (1/3- and 1/2-stop increments), X-sync at 1/250 sec.
Shutter Release: Soft-touch electromagnetic release
Self-Timer: 10-sec. delay, 2-sec. delay with C.Fn-12-1 (mirror lockup)
Remote Control: Remote control with N3-type terminal

FLASH **Built-in Flash:** Auto pop-up, retractable, built-in flash in the pentaprism (user must activate flash in P, Av, Tv and M modes)
Flash coverage: Up to 17mm focal length (equivalent to 27mm in 35mm format)
EOS-dedicated Speedlite: E-TTL II autoflash with EX Series Speedlites

DRIVE SYSTEM **Drive Modes:** Single, Continuous, Self-timer
Continuous Shooting Speed: High-speed approx. 5 fps / low-speed approx. 3 fps (at a shutter speed of 1/250 sec. or faster)
Max. Burst During Continuous Shooting: JPEG: high-speed approx. 30 frames (Large/Fine), RAW: high-/low-speed approx. 11 frames, RAW+JPEG: high-/low-speed approx. 9 frames

LCD MONITOR **Type:** TFT color, liquid-crystal monitor
Monitor Size: 2.5 in. diagonal with a viewing angle of approx. 170° vertically and horizontally
Pixels: Approx. 230,000 pixels
Coverage: Approx. 100%
Brightness Adjustment: 5 levels (settable with menu's "LCD brightness")

IMAGE PLAYBACK **Image Display Formats:**
(1) Single image, (2) 9-image index, (3) Magnified zoom (single image) up to 10x,
(4) Auto play (5) Auto play right after shooting
Highlight Alert: In the single image (INFO) display mode, the areas with highlights containing no image information will blink

IMAGE PROTECTION AND ERASE **Protection:** A single image can be protected or unprotected
Erase: A single image or all images stored in a CF card can be erased if they are unprotected
Format: Complete initialization of CF card available in setup menu

MENUS **Menu Categories:** (1) Shooting Menu: red, (2) Playback Menu: blue, (3) Setup Menu: yellow
LCD Monitor Language: English, German, French, Dutch, Danish, Finnish, Italian, Norwegian, Swedish, Spanish, Russian, Simplified/Traditional Chinese, Korean, Japanese
Firmware Update: Enabled by the user (in Creative Zone only)

POWER SOURCE **Battery:** One Battery Pack BP-511A/511/512/514 (lithium-ion rechargeable battery)
Number of Shots:

DIMENSIONS AND WEIGHT **Dimensions (W x H x D):** 5.7 x 4.2 x 2.9 in. / 144 x 105.5 x 73.5mm
Weight: 24.7 oz. / 700g (Body only)

OPERATING CONDITIONS **Operating Temperature Range:** 32–104°F/0–40°C
Operating Humidity: 85% or less

Canon and DIGIC are registered trademarks, and PIXMA is a trademark, of Canon Inc. in the United States and may also be registered trademarks or trademarks in other countries. All other products and brand names are registered trademarks, trademarks or service marks of their respective owners.

System Chart

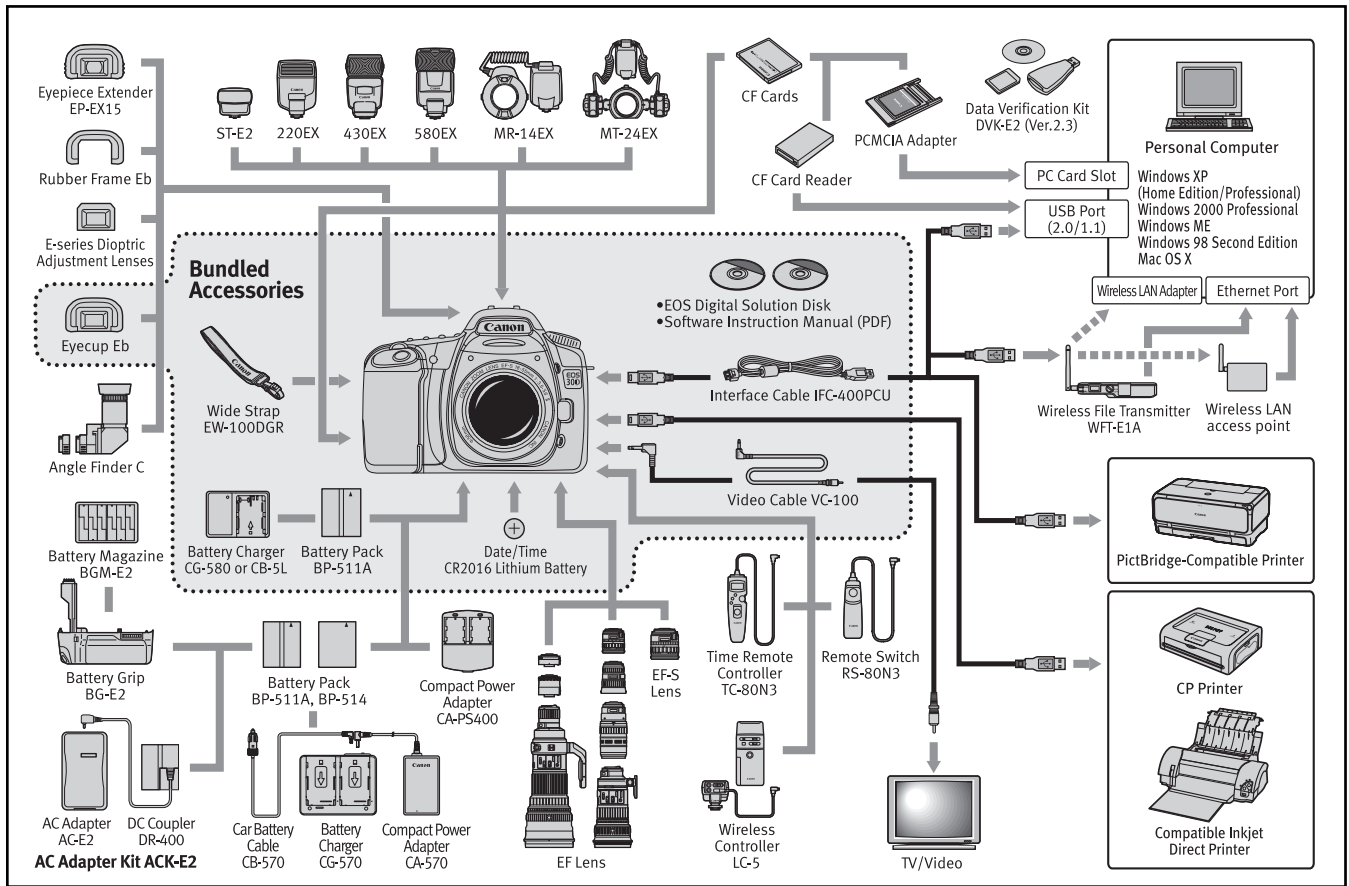

VII. CONCLUSION

The EOS 30D is a new camera that stands firmly on the shoulders of the EOS 20D, as well as the entire Canon EOS System. Because it is based on the highly successful 20D, customers will understand that they are investing in an established, reliable product. As the digital photography business matures, people are developing a more sophisticated appreciation of matters such as long-term reliability, component consistency and complementary system characteristics. These goals are difficult to achieve when key components are outsourced. Canon's dedication to the research, development and manufacturing of CMOS chips means that they control short and long-term sensor reliability. The Canon natural color "look" is the product of an imaging philosophy that Canon implements at each step in the image path from the glass in its lenses to the software that performs RAW file conversion.

Each Canon camera is designed to meet the needs of a particular customer category. The EOS 30D is aimed at advanced amateurs and professionals who buy their own equipment. They require high performance and genuine, lasting value. Many of them own more than one body or expect to upgrade in the future. If they trade in, they expect their old equipment to retain a reasonable portion of its original cost. If they keep their gear and buy new, the old and new must work perfectly together. Commitments such as the backward compatibility of DPP to the EOS D6000 and the D2000, as well as the introduction of the EF-S 17–55mm f/2.8 IS USM and the EF 85mm f/1.2L II USM lenses, demonstrate that the Canon EOS System will respect the past even as it grows constantly. While it makes a strong case for itself as a separate device, the EOS 30D provides a clear upgrade path to the EOS 5D and the EOS-1D Mark II N, links to an ever more sophisticated Canon-to-Canon workflow and fits neatly into the vast Canon EOS System of lenses, bodies, flashes, accessories, software and printers.

New, new, new is certainly exciting, and a healthy dose of it keeps the wheels of possibility spinning in our heads. Still, tried-and-true, or tried-and-true-but-very-much-modern-and-current, has a genuine appeal, especially to the person who's paying for it. The wedding and portrait photographers, journalists, news organizations and serious amateurs who will buy the EOS 30D will get their money's worth and much, much more, and they will never, ever second-guess themselves about the wisdom of their purchase.

⁴Actual selling price will be set by dealers and may vary.

Contents ©2006 by Canon U.S.A., Inc. All Rights Reserved. Excerpts from this material may be quoted in published product reviews and articles. For further information, please contact Canon U.S.A., Inc. Public Relations Dept., (516) 328-5000.